



Essens Table

INCLASS

DESIGN Jonathan Prestwich
Inclass, Italy

The Essens table combines beauty, design and harmonious proportions. The meeting point between two essential volumes in equilibrium, generates a table with a sculptural outline that fits perfectly in all kinds of indoor and outdoor spaces alike.

Made from 100% recyclable polyethylene, the Essens table programme includes 5 unique bases for composing tables in a variety of formats and finishes.

LEAD TIME

6 weeks for stock colours

12 weeks for other

WARRANTY

3 year structural

CERTIFICATION

UNE EN 13761

AIDIMA Quality Control Label

ISO 9001:2015

ISO 14,001:2004

Product Stewardship Programme

RESOURCES AVAILABLE

Drawing files

Images

Certification

SYDNEY
5/50 Stanley Street
Darlinghurst
+61 2 9358 1155

MELBOURNE
11 Stanley Street
Collingwood
+61 3 9416 4822

ownworld.com.au

Essens Table Collection

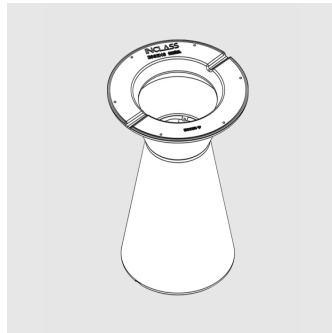

ESSENS 380 BASE
Meeting/Dining Table

DIMENSIONS
DIA 380/480 H 720 (mm)



CODE
ES10010BA
ES300100P (gravel
counterweight)

WEIGHT
5.2kg
25kg

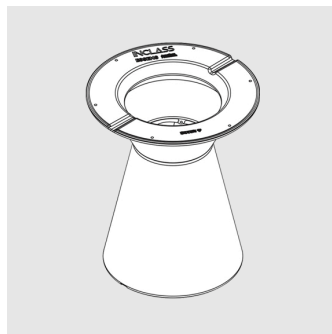

ESSENS 500 BASE
Meeting/Dining Table

DIMENSIONS
DIA 500/620 H 720 (mm)



CODE
ES10020BA
ES300140P (gravel
counterweight)

WEIGHT
10.4kg
50kg



ESSENS 650 BASE
Meeting/Dining Table

DIMENSIONS
DIA 650/770 H 720 (mm)



CODE
ES10050BA
ES300160P (gravel
counterweight)

WEIGHT
13kg
75kg



ESSENS 380 HIGH BASE
Meeting/Dining Table

DIMENSIONS
DIA 380/480 H 1085 (mm)



CODE
ES10040BA
ES300100P (gravel
counterweight)

WEIGHT
6.8kg
25kg

Essens Table Collection



ESSENS OVAL BASE

Meeting/Conference/Boardroom Table

DIMENSIONS

W 700 D 400 H 720 (mm)

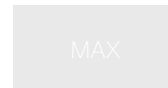

No length limit

CODE

ES10030BA

ES300120P (gravel
counter weight)

WEIGHT

6.1kg

40kg



PRODUCT DATASHEET

Essens Materials & Finishes

STANDARD BASE FINISH:	Produced in 100% recyclable, roto-moulded solid colour Polyurethane, available in standard house colours with matt finish.
COMPOSED BASE FINISH:	Produced in 100% recyclable, roto-moulded solid colour Polyurethane, available in Rust Brown or Cement with matt finish.
METALLIC PAINTED BASE:	Produced in 100% recyclable, roto-moulded Polyurethane, finished to metallic paint in house colour.
STANDARD PAINTED BASE:	Produced in 100% recyclable, roto-moulded Polyurethane, painted with matt epoxy paint in house colour. White W01 and Black 00 are available in a gloss finish. Custom colours are available at an additional cost.
TABLE TOPS:	Tops are manufactured locally according to specification. Table size, thickness, edge detail and finish can be customised based on the application requirement. Finish options include; Veneer, laminated MDF, Marble, HPL and lacquered MDF.

STANDARD PLASTIC



Plastic | Polyurethane
Black Boo

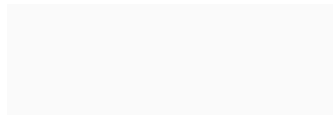

Plastic | Polyurethane
White W01



Plastic | Polyurethane
Anthracite G49



Plastic | Polyurethane
Grey G42



Plastic | Polyurethane
Sand M82

PLASTIC - COMPOSED

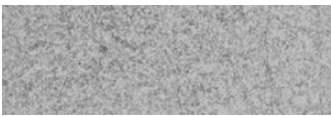

Plastic | Composed Colour
Cement Grey

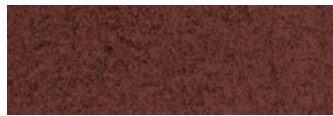

Plastic | Composed Colour
Rust Brown

Essens Materials & Finishes Cont.

PLASTIC - METALLIC



Plastic | Metallic Paint
Gold



Plastic | Metallic Paint
Silver



Plastic | Metallic Paint
Copper

PLASTIC - STANDARD PAINT



Plastic | Standard Paint
Teal Green B40



Plastic | Standard Paint
Sage Green V16



Plastic | Standard Paint
Ochre Y62



Plastic | Standard Paint
Orange O25



Plastic | Standard Paint
Dusty Pink P70



Plastic | Standard Paint
Mushroom M56



Plastic | Standard Paint
Dark Blue B36



Plastic | Standard Paint
Steel Blue B44

Essens - Example Finishes

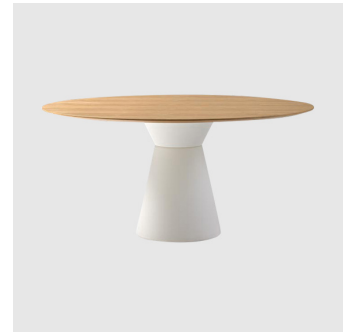

SYDNEY
5/50 Stanley Street
Darlinghurst
+61 2 9358 1155

MELBOURNE
11 Stanley Street
Collingwood
+61 3 9416 4822

ownworld.com.au